

VOLLEYBALL IRELAND



REFEREE GUIDELINES

1. Introduction & Art of refereeing

Refereeing is not just about conducting a match following the Rules of the Game by the letter of the law.

It takes years of experience as referee to realize that you are not just another spectator, but an integral part of the game itself, like all the players.



The referee must be an expert and a friend, working for the game and with the players.

Volleyball is described by the FIVB as *“fast, exciting and the action is explosive”*. They also indicate two key mindsets when refereeing a match:

Get involved! Keep the ball flying!

Do’s

Don’ts

Remain in the background of the action. The best referee may well be the one that isn’t remembered and that remains in the background.	Do not try to “lead” the game by negative decisions and penalties.
Keep the game flowing. Disregard small infractions during spectacular rallies.	Do not call every minimal infraction. Keep the game going unless necessary.
Keep a friendly relationship with players, coaches, etc.	Do not impose yourself, or take criticism or comments personally.
Reward the players and teams for spectacular and exciting actions in the <u>spirit</u> of the Rules.	Do not over-sanction incorrect behaviors. Frustration in players can be a natural reaction of a losing team who is involved in the match.
Enjoy the game.	

1. Responsibilities, duties and authority

1.1. First Referee

- The referee is in charge of the match.
- From the moment you arrive on site you are in charge of the court/playing area. Your authority extends over other officials, coaches, and players, but not spectators.
- *If any issues arise you need to take charge.* For instance, if the scorekeeper makes a mistake in the score, you need to help correct the mistake, if you can.
- *The officials are there to assist you* (scorekeeper, second referee, line judges, etc). Let others complete their own specific duties. As the first referee, you have the authority to overrule or if need be, replace a member of the officiating crew.
- Issues with the *behavior of the public must be taken care by the Home team / Organizers.* This is usually done by a volleyball official alerting the site/school administrator of the problem.
- The 1st referee may change any decision of his/her fellow officials or of his/her own. If he/she has made a decision (whistled) and then sees that his/her colleagues (2nd referee, line judges or scorer) have, for instance, made different decision:
 - 1) if he/she is sure that he/she is right, he/she may stick to his/her decision;
 - 2) if he/she sees that he/she was wrong, he/she may change his/her decision;
 - 3) if he/she states that faults were committed simultaneously by both teams (players), he/she should signal for the rally to be replayed;



1.2. Second Referee

- If the first referee cannot perform his/her duty, the second referee should replace him/her.
- Concentrate on decisions regarding the *contact of the player with the net, penetration* on to the opponent's court beyond the center line, and on the *actions on the side of the block*. The second referee's main focus remains near the net, and at the same time he/she must have good peripheral awareness but must resist the temptation to watch the ball as it passes into the back court.
- Also concentrate on the positions of the receiving team during service and not watch the server.
- Even when there are no line judges, the second referee *does not make in/out line call decisions* – they are the responsibility of the first referee unless not visible by the first ref and the 2nd ref happens to see it.
 - Touching the net between the antennae or the antenna itself during his/her action of playing the ball,
 - Using the net between the antennae as a support or stabilizing aid



1.3. Scorekeeper

- Scorers must be competent and referees must note on the scoresheet where this is not the case. (Please write, e.g. “*scoresheet not completed correctly*”, rather than “*incompetent scorer*”.)
- A manually operated scoreboard, placed on the scorer's table, is compulsory for all matches. If an electronic scoreboard is used, this is in conjunction with the manual scoreboard and not in place of it.

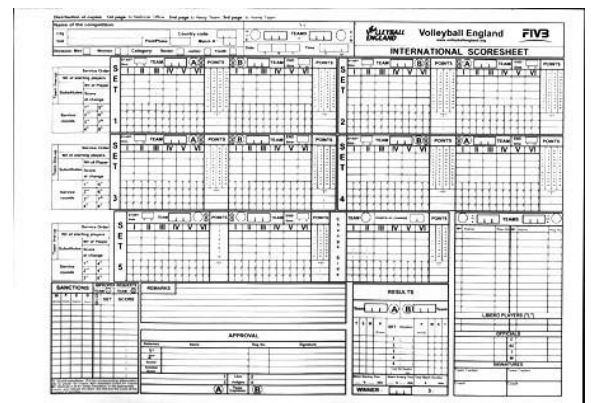

1.4. Sanctions

- Remember that not all misconducts are subject to sanctions. It is the 1st referee's duty to prevent the teams from approaching the sanctioning level and this can be done in two stages:
 - 1) A **verbal warning** through the game captain (no cards, no registration on the score sheet).
 - 2) By use of a **yellow card** to a team member. This warning is not a sanction but a symbol that the team member (and by extension the team) has reached the sanctioning level for the match. It has no immediate consequences, but is recorded on the score sheet.
- Apply **minor misconduct warnings** and misconduct leading to sanctions penalties as and **when they arise, and if appropriate**. Failure to act appropriately, may give the impression that unacceptable behavior may be tolerated.
- There can be only **one yellow card per team per match**. The **next misconduct** by any team member must be dealt with by way of a **red card** (or red and yellow if the seriousness of the second misconduct appropriate).

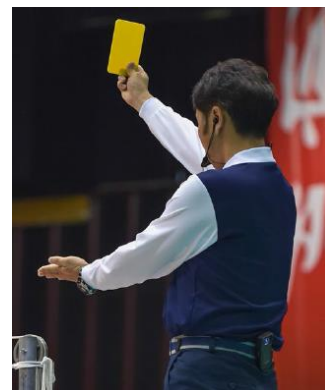

CATEGORIES	OCCURRENCE	OFFENDER	SANCTION	CARDS	CONSEQUENCE
MINOR MISCONDUCT	Stage 1	Any member	Not considered as sanction	None	Prevention only
	Stage 2			Yellow	
	repetition any time		Penalty	as below	as below
RUDE CONDUCT	First	Any member	Penalty	Red	A point and service to the opponent
	Second	Same member	Expulsion	Red + Yellow jointly	Player leaves playing area and stays in the penalty area for the remainder of the set
	Third	Same member	Disqualification	Red + Yellow separately	Player leaves the Competition-Control Area for the remainder of the match
OFFENSIVE CONDUCT	First	Any member	Expulsion	Red + Yellow jointly	Player leaves the playing area and stays in the penalty area for the remainder of the set
	Second	Same member	Disqualification	Red + Yellow separately	Player leaves the Competition-Control Area for the remainder of the match
AGGRESSION	First	Any member	Disqualification	Red + Yellow separately	Player leaves the Competition-Control Area for the remainder of the match

2. Preparation

2.1. Personal Equipment

- Preparation has many elements, but fundamental to refereeing well and being viewed as adopting a professional approach, referees must ensure that the following are in order prior to the match.
- Uniform should be prepared, clean and well presented

2.2. VI Referee Uniform Code

- Top: White VI Referee Polo Shirt or Sweat Shirt.
- Trousers: Navy blue – white belt optional.

Jeans, chinos, cords etc., or tracksuit bottoms of any variety are **not** acceptable

- Shoes: Predominantly white, clean sport shoes
- Socks: White.

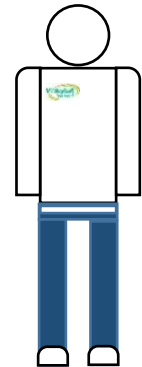

The rules insist on players wearing approved kit; It is only right and proper therefore (and *compulsory*) for *all* referees to comply with the uniform code in all official matches

2.3. Referees Equipment

Referees should ensure that they have with them the equipment necessary to carry out their tasks as specified in the rules. Essential items include the following:

- Whistles (including a spare)
- Coin – to conduct the toss
- Measuring rod or net height chain or tape measure
- Ball pressure gauge
- Ball pump and adaptors
- Yellow and Red Sanction nets
- Ball point pen(s)
- Current Registration Card
- Rule Book, Competition Handbook (Tournament Rules)
- Watch

3. Equipment

3.1. Playing Area

Prior to the match the referee must check for any irregularities regarding the playing area. Particular attention should be paid to the playing surface and any equipment which may prove a danger to participants.

3.2. Net and posts

- Sports Centre Staff and/or the Home team are responsible for the correct and safe set up of the net and posts, for the referee stand and any other equipment required for the proper completion of the game.

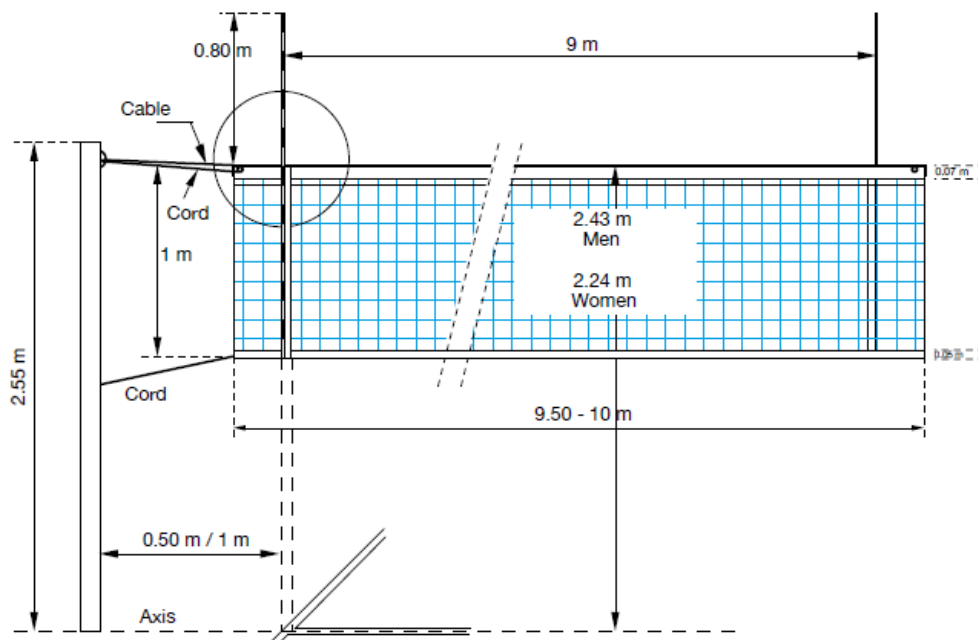

3.3. Balls

Only approved FIVB balls may be used (as notified by the VI). If the correct balls are not available the match is still played but the relevant details are recorded on the scoresheet under Remarks. Its pressure should be 0.30 to 0.325 kg/cm² (4.26 to 4.61 psi) (294.3 to 318.82 mbar or hPa).

for the lack of equipment.

4. Participants

4.1. Teams

- Using the registration cards, referees must *check team member eligibility before the match*.
- Only three others can take a place on the bench: *One coach, one assistant coach, and one trainer/physiotherapist*. All three must be in possession of bench personnel *registration cards as per VI Competition Rules*. All bench personnel must be recorded on the scoresheet.
- *Team members should not leave the Competition Area without the permission of the referee(s)*.

4.2. Team Captains

- Team Captains should be identified in the Scoresheet.
- *Only the captain and the coach may intervene during the game*. If the game captain is substituted, or is not in the starting line-up for the set, the second referee should check with the coach or team captain who the game captain is and inform the first referee. If the Team captain is substituted, he/she loses this right whilst sitting on the bench or in the warm-up area. The right passes to the game captain.

4.3. Coaches

- The coach, substitutes *seated* on the bench, and players in the warm-up area, may give instructions or communicate with their team. This must be done without disturbing or delaying the match.
- The coach does not have the right to request anything from the members of the refereeing corps, except the regular game interruptions (time-outs and substitutions). The coach can request to verify the score or the number of used time-out/substitutions, but only when the ball is out of play.
- The assistant coach may sit anywhere on the team bench, but has no right to intervene in the match. The assistant coach is not permitted to call time-outs or substitutions if the coach becomes a player on court.

4.4. Warm Up

17+ Minutes before start

The referees check the height and tension of the net as well as the position of the antennae and side markings.

16 Minutes before start

The two referees and both team captains' report to the area in front of the scorer's table. The coin toss follows after which the first referee informs the scorer about the result of the toss. Team captains sign the score sheet.

15 Minutes before start

The first referee blows his whistle to signal the start of the official warm-up. Hitting and service practise is conducted at this stage. The referees check the equipment for the game, i.e., match balls, score sheet, uniforms etc. Referees have to give any necessary instructions to line judges, ball retrievers, etc. The referees will control the warm-up.

12 Minutes before start

The second referee must ensure that the coach of each team submits a line-up sheet for the first set to the scorer who records the six starting players of each team on the score sheet.

5 Minutes before start

The first referee whistles, indicating the end of the warm-up of the teams. If players must change their jerseys, they must leave the playing court and return with little or no delay. All team members must be wearing their match uniforms.

4 Minutes before start

Both referees stand in the middle of the court, perpendicular and close to the net. At the first referee whistle the players enter the court lining up laterally in the middle of the court facing the scorer. The first referee whistles for the players of the two teams to fist bump at the net and then return to their benches.

2.5 Minutes before start

Both referees go to their normal positions.

2 Minutes before start

First referee will blow the whistle for the teams to line-up at the baseline, and then whistle for players to enter the court.

Second referee checks the players starting positions. The second referee checks that the scorer is also finished checking and is ready to start. Then he/she gives the ball to the server.

Match start

The first referee blows the whistle to authorise the first service of the match.

Notes :

- Fist bumps are recommended between teams, captains and officials, instead of handshakes.
- The wearing of a face mask is a personal choice and is not compulsory.
- Proof of vaccinations is not compulsory.
- Electronic whistles are permitted for all games.
- It is recommended that all officials bring and use their own pens throughout all games.
- It is recommended that the match ball be sanitised at the beginning of the game and at the end of each set.
- Each home team should provide hand sanitiser at the scoresheet table.
- Each team should pay 50% of the official's expenses.

- If anyone is suffering from Covid 19 symptoms, self-isolation is still compulsory as per government guidelines.

5. Useful Links

- FIVB website: <http://www.fivb.com/>
- FIVB Refereeing section: <http://www.fivb.org/EN/Refereeing-Rules/>
- FIVB rules page, including Casebook and guidelines: http://www.fivb.org/EN/Refereeing-Rules/RulesOfTheGame_VB.asp

HAND SIGNALS

The official hand signals are shown below (official FIVB signals):



VOLLEYBALL OFFICIAL HAND SIGNALS

REFEREES' OFFICIAL HAND SIGNALS

<p>1 AUTHORISATION TO SERVE Relevant Rules: 12.3, 22.2.1.1 Move the hand to indicate direction of service</p>
<p>2 TEAM TO SERVE Relevant Rules: 22.2.3.1, 22.2.3.2, 22.2.3.4 Extend the arm to the side of team that will serve</p>
<p>3 CHANGE OF COURTS Relevant Rule: 18.2 Raise the forearms front and back and twist them around the body</p>
<p>4 TIME-OUT Relevant Rule: 15.4.1 Place the palm of one hand over the fingers of the other, held vertically (forming a T) and then indicate the requesting team</p>
<p>5 SUBSTITUTION Relevant Rules: 15.5.1, 15.5.2, 15.8 Circular motion of the forearms around each other</p>
<p>6a MISCONDUCT WARNING Relevant Rule: 21.1, 21.6 Show a yellow card for warning</p>
<p>6b MISCONDUCT PENALTY Relevant Rules: 21.3.1, 21.6, 23.3.2.2 Show a red card for penalty</p>
<p>7 EXPULSION Relevant Rules: 21.3.2, 21.6, 23.3.2.2 Show both cards jointly for expulsion</p>
<p>8 DISQUALIFICATION Relevant Rules: 21.3.3, 21.6, 23.3.2.2 Show red and yellow cards separately for disqualification</p>
<p>9 END OF SET (OR MATCH) Relevant Rules: 6.2, 6.3 Cross the forearms in front of the chest, hands open</p>

<p>10 BALL NOT TOSSED OR RELEASED AT THE SERVICE HIT Relevant Rule: 12.4.1 Lift the extended arm, the palm of the hand facing upwards</p>
<p>11 DELAY IN SERVICE Relevant Rule: 12.4.4 Raise eight fingers, spread open</p>
<p>12 BLOCKING FAULT OR SCREENING Relevant Rules: 12.5, 12.6.2.3, 14.6.3, 19.3.1.3, 23.3.2.3a, g, 24.3.2.4 Raise both arms vertically, palms forward</p>
<p>13 POSITIONAL OR ROTATIONAL FAULT Relevant Rules: 7.5, 7.7, 23.3.2.3a, 24.3.2.2 Make a circular motion with the forefinger</p>
<p>14 BALL "IN" Relevant Rule: 8.3 Point the arm and fingers toward the floor</p>
<p>15 BALL "OUT" Relevant Rules: 8.4.1, 8.4.2, 8.4.3, 8.4.4, 24.3.2.5, 24.3.2.7 Raise the forearms vertically, hands open, palms towards the body</p>
<p>16 CATCH Relevant Rules: 9.2.2, 9.3.3, 23.3.2.3b Slowly lift the forearm, palm of the hand facing upwards</p>
<p>17 DOUBLE CONTACT Relevant Rules: 9.3.4, 23.3.2.3b Raise two fingers, spread open</p>
<p>18 FOUR HITS Relevant Rules: 9.3.1, 23.3.2.3b Raise four fingers, spread open</p>
<p>19 NET TOUCHED BY PLAYER - SERVED BALL TOUCHES THE NET BETWEEN THE ANTENNAE AND DOES NOT PASS THE VERTICAL PLANE OF THE NET Relevant Rules: 11.4.4, 12.6.2.1 Indicate the relevant side of the net with the corresponding hand</p>
<p>20 REACHING BEYOND THE NET Relevant Rules: 11.4.1, 13.3.1, 14.3, 14.6.1, 23.3.2.3c Place a hand above the net, palm facing downwards</p>

<p>21 ATTACK HIT FAULT Relevant Rules: - by a back-row player, by a libero or on the opponent's service: 13.3.3, 13.3.4, 13.3.5, 23.3.2.3d, e, 24.3.2.4 - on an overhand finger pass by the libero in his/her front zone or its extension: 13.3.6 Make a downward motion with the forearm, hand open</p>
<p>22 PENETRATION INTO THE OPPONENT COURT BALL CROSSING THE LOWER SPACE OR THE SERVER TOUCHES THE COURT (END LINE) OR THE PLAYER STEPS OUTSIDE HIS/HER COURT AT THE MOMENT OF THE SERVICE HIT Relevant Rules: 8.4.5, 11.2.2, 12.4.3, 23.3.2.3a, f, 24.3.2.1 Point to the center line or to the relevant line</p>
<p>23 DOUBLE FAULT AND REPLAY Relevant Rules: 6.1.2.2, 17.2, 22.2.3.4 Raise both thumbs vertically</p>
<p>24 BALL TOUCHED Relevant Rules: 23.3.2.3b, 24.2.2 Brush with the palm of one hand the fingers of the other, held vertically</p>
<p>25 DELAY WARNING/DELAY PENALTY Relevant Rules: 15.11.3, 16.2.2, 16.2.3, 23.3.2.2 Cover the wrist with a yellow card (warning) and with a red card (penalty)</p>

LINE JUDGES' OFFICIAL FLAG SIGNALS

<p>1 BALL "IN" Relevant Rule: 8.3, 27.2.1.1 Point down with flag</p>
<p>2 BALL "OUT" Relevant Rules: 8.4.1, 27.2.1.1 Raise flag vertically</p>
<p>3 BALL TOUCHED Relevant Rule: 27.2.1.2 Raise flag and touch the top with the palm of the free hand</p>
<p>4 CROSSING SPACE FAULTS, BALL TOUCHED AN OUTSIDE OBJECT, OR FOOT FAULT BY ANY PLAYER DURING SERVICE Relevant Rules: 8.4.2, 8.4.3, 8.4.4, 12.4.3, 27.2.1.3, 27.2.1.4, 27.2.1.6, 27.2.1.7 Wave flag over the head and point to the antenna or the respective line</p>
<p>5 JUDGEMENT IMPOSSIBLE Raise and cross both arms and hands in front of the chest</p>

Legend:
 Referee(s) who must show the signal according to their regular responsibilities
 Referee(s) who show the signal in special situations



Part of **OFFICIAL VOLLEYBALL RULES 2017-2020** (approved by the 35th FIVB Congress 2016)

Published by FIVB in 2016 – www.fivb.org
 Design and layout: Samuel Chesaux
 Illustrations: © FIVB 2014

5.1. Additional signals

Additional signals are listed below. These are not official FIVB signals, but are widely used at national and international level.

READY FOR RALLY
Hands open, palms forwards, not higher than the head



S

CAN'T JUDGE
Cover both eyes with open hands



F S

CALL CAPTAINS
Point at an imaginary line on the chest



F S